

Page 1-2 stand for
TCO'99 model only.
Please See back label
for model distinction.



Congratulations!

You have just purchased a TCO'99 approved and labelled product! Your choice has provided you with a product developed for professional use. Your purchase has also contributed to reducing the burden on the environment and also to the further development of environmentally adapted electronics products.

Why do we have environmentally labelled computers?

In many countries, environmental labelling has become an established method for encouraging the adaptation of goods and services to the environment. The main problem, as far as computers and other electronics equipment are concerned, is that environmentally harmful substances are used both in the products and during their manufacture. Since it is not so far possible to satisfactorily recycle the majority of electronics equipment, most of these potentially damaging substances sooner or later enter nature.

There are also other characteristics of a computer, such as energy consumption levels, that are important from the viewpoints of both the work (internal) and natural (external) environments. Since all methods of electricity generation have a negative effect on the environment (e.g. acidic and climate-influencing emissions, radioactive waste), it is vital to save energy. Electronics equipment in offices is often left running continuously and thereby consumes a lot of energy.

What does labelling involve?

This product meets the requirements for the TCO'99 scheme which provides for international and environmental labelling of personal

computers. The labelling scheme was developed as a joint effort by the TCO (The Swedish Confederation of Professional Employees), Svenska Naturskyddsforeningen (The Swedish Society for Nature Conservation) and Statens Energimyndighet (The Swedish National Energy Administration).

Approval requirements cover a wide range of issues: environment, ergonomics, usability, emission of electric and magnetic fields, energy consumption and electrical and fire safety.

The environmental demands impose restrictions on the presence and use of heavy metals, brominated and chlorinated flame retardants, CFCs (freons) and chlorinated solvents, among other things. The product must be prepared for recycling and the manufacturer is obliged to have an environmental policy which must be adhered to in each country where the company implements its operational policy.

The energy requirements include a demand that the computer and/or display, after a certain period of inactivity, shall reduce its power consumption to a lower level in one or more stages. The length of time to reactivate the computer shall be reasonable for the user.

Labelled products must meet strict environmental demands, for example, in respect of the reduction of electric and magnetic fields, physical and visual ergonomics and good usability.

On the Back page of this folder, you will find a brief summary of the environmental requirements met by this product. The complete environmental criteria document may be ordered from:

TCO Development

SE-114 94 Stockholm, Sweden

Fax: +46 8 782 92 07

Email (Internet): development@tco.se

Current information regarding TCO'99 approved and labelled products may also be

obtained via the Internet, using the address: <http://www.tco-info.com/>

Environmental requirements

Flame retardants

Flame retardants are present in printed circuit boards, cables, wires, casings and housings. Their purpose is to prevent, or at least to delay the spread of fire. Up to 30% of the plastic in a computer casing can consist of flame retardant substances. Most flame retardants contain bromine or chloride, and those flame retardants are chemically related to another group of environmental toxins, PCBs. Both the flame retardants containing bromine or chloride and the PCBs are suspected of giving rise to severe health effects, including reproductive damage in fish-eating birds and mammals, due to the bio-accumulative* processes. Flame retardants have been found in human blood and researchers fear that disturbances in foetus development may occur.

The relevant TCO'99 demand requires that plastic components weighing more than 25 grams must not contain flame retardants with organically bound bromine or chlorine. Flame retardants are allowed in the printed circuit boards since no substitutes are available.

Cadmium

Cadmium is present in rechargeable batteries and in the colour-

* *Bio-accumulative is defined as substances which accumulate within living organisms*

generating layers of certain computer displays. Cadmium damages the nervous system and is toxic in high doses. The relevant TCO'99 requirement states that batteries, the colour-generating layers of display screens and the electrical or electronics components must not contain any cadmium.

Mercury

Mercury is sometimes found in batteries, relays and switches. It damages the nervous system and is toxic in high doses. The relevant TCO'99 requirement states that batteries may not contain any mercury. It also demands that mercury is not present in any of the electrical or electronics components associated with the labelled unit.

CFCs (freons)

The relevant TCO'99 requirement states that neither CFCs nor HCFCs may be used during the manufacture and assembly of the product. CFCs (freons) are sometimes used for washing printed circuit boards. CFCs break down ozone and thereby damage the ozone layer in the stratosphere, causing increased reception on earth of ultraviolet light with e.g. increased risks of skin cancer (malignant melanoma) as a consequence.

Lead**

Lead can be found in picture tubes, display screens, solders and capacitors. Lead damages the nervous system and in higher doses, causes lead poisoning. The relevant TCO'99 requirement permits the inclusion of lead since no replacement has yet been developed.

*** Lead, Cadmium and Mercury are heavy metals which are Bio-accumulative.*

Operation Instructions

Thank you for purchasing this monitor, a high-resolution multi-scan color monitor. Please read this guide thoroughly before installation.

FCC RADIO FREQUENCY INTERFERENCE STATEMENT

WARNING: (FOR FCC CERTIFIED MODELS)

This monitor has been tested and found compliant with the limits for a Class B digital device, pursuant to part 15 of the FCC Rules. These limits are designed to provide proper protection against harmful interference to a residential installation. This monitor generates, uses, and can radiate radio frequency energy. Harmful interference to radio communication may be led as a result if it's not properly installed and used. However, there is no guarantee that interference will not occur in a particular installation. If this monitor does cause serious interference to radio or television reception, resetting the monitor may determine it. Moreover, users are encouraged to correct interference by doing one or more of the following:

- Reorient or relocate the receiving antenna.
- Move the monitor and the receiver further away from each other.
- Connect the monitor into an outlet on a circuit different from that to which the receiver is connected.
- Consult your local dealer or an qualified technician.

FCC Warning:

To assure a continued FCC compliance, a user must use a grounded power supply cord and the provided shielded video interface cable with bonded ferrite cores. Also, any unauthorized changes or modifications to this monitor would void the user's authority to operate this device.

Note: If necessary, shielded interface cables and A.C. power cord must be used to meet the emission level limits.

EMI Certification

The Class B digital apparatus meets all requirements of the Canadian Interference-Causing Equipment Regulation.

Cet appareil numérique de class B respecte toutes les exigences du Reglement sur le materiel brouilleur du Canada.

Content

First Step	1
Front Panel Control.....	2
Installation.....	2
Using OSD Functions	3
Timing modes	4
Technical Information.....	5
Safety Precautions.....	6
Care and Maintenance.....	7

First Step

Thank you for purchasing this monitor of high performance!

This monitor package comes with:

- ❖ Video cable with 15 pin D-SUB connector.
- ❖ Power cable.
- ❖ User guidebook or CD-ROM (You're reading now)

Quick

Installation

1. Connect video cable

Make sure both the monitor and computer are powered OFF. Connect the video cable to the computer, then to the monitor.

2. Connect power cord

Connect the power cord to a properly grounded AC outlet, then to the monitor.

3. Power-ON computer and monitor

Power-ON the computer, then Power-ON the monitor.

4. Windows users:Setting the

Timing Mode (Resolution and Refresh Rate)

Example: 800 x 600 @ 75 Hz

Resolution Right-click on the Windows desktop > Properties > Settings > "Desktop Area". Set the resolution.

Refresh Rate (vertical frequency) See your graphic card's user guide for instructions.

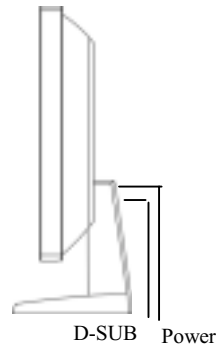

Front Panel Control

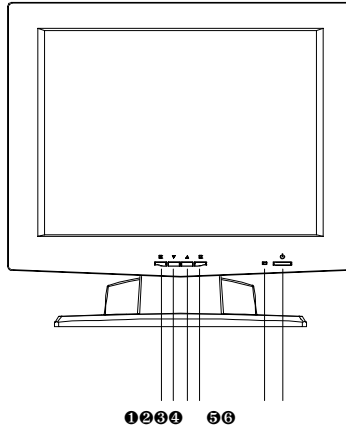

- | | |
|---------------|-------------------|
| ❶ OSD ON/OFF | ❹ ENTER |
| ❷ SCROLL DOWN | ❺ POWER INDICATOR |
| ❸ SCROLL UP | ❻ POWER ON/OFF |



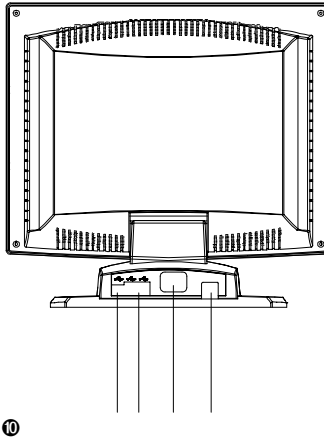





Installation

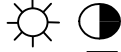

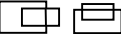
- | |
|----------------------------------|
| ❷ USB UP STREAM PORT |
| ❸ USB 4 DOWN STREAM PORTS |
| ❹ POWER INPUT (AC INPUT) |
| ❺ SINGAL INPUT (VGA 15PIN D-SUB) |

Using OSD Functions

MAIN MENU(example)

48.3 KHZ / 60.0 HZ		1024X768	
		AUTO ADJUST	
		BRIGHTNESS / CONTRAST	
		PHASE / CLOCK	
		H-POSITION/V-POSITION	
		SMOOTH	
		COLOR ADJUSTMENT	
DOS-MODE / SELECT	720x400		
		LANGUAGE	
		OSD-POSITION	
		RECALL	
EXIT: 1		ENTER: 2	

AUTO-ADJUST :Auto. adjust horizontal position ,clock, vertical position and phase.

H-POSITION: To adjust the horizontal position of the video.

V-POSITION: To adjust the vertical position of the video.

BRIGHTNESS: To adjust the back-light current.

CONTRAST: To adjust the contrast of the video.

PHASE: To adjust the delay time between horizontal synchronous signal and video.

CLOCK: To adjust video display horizontal pixels clock.

SMOOTH: To select interpolation mode exclude 1024x 768 timing.(Sharp or smooth)





OSD-POSITION: To select OSD position .

COLOR ADJUSTMENT: To adjust R.G.B GAMMA correction.

DOS-MODE SELECT: To select 720x 400 or 640x 400.

LANGUAGE: Five language to selection. (ENGLISH, FRENCH, GERMAN, ITALIAN, SPANISH)

RECALL: To revert adjustment of screen function before save.

1. Press “”button OSD to be turned off.
2. Press “” or “” button to scroll up/down.
3. Press “” button go into selected function OSD to the sub-menu.

Hot Key function:

When no OSD whenever press.

“” Button OSD to be turned on/off.

“”Button the montior will auto-adjustment and save.

“” button to adjust brightness.

“” button to adjust contast.

Timing modes

VESA	640 x 400 @ 70HZ
VESA	720 x 400 @ 70HZ
VESA	640 x 480 @ 60HZ
VESA	640 x 480 @ 67HZ
VESA	640 x 480 @ 75HZ
VESA	800 x 600 @ 56HZ
VESA	800 x 600 @ 60HZ
VESA	800 x 600 @ 72HZ
VESA	800 x 600 @ 75HZ
MAC	832 x 624 @ 75HZ
VESA	1024 x 768 @ 60HZ
VESA	1024 x 768 @ 70HZ
VESA	1024 x 768 @ 75 Hz

Technical Information

Technical Specification

LCD Panel	15.0" TFT	
Power Management	Energy Star compliant VESA DPMS compatible < 5 W	
Displayable Resolution	XVGA 1024 x 768 max. Vertical Frequency 75Hz max.	
Pixel Dimension	0.297 x 0.297 mm	
LCD Display Color	16.7M(8 bits/color)	
Viewing Angle		15.0" (typical) CR ≥ 10
	Horizontal	-60° + 60°(typical)
	Vertical	-55°+ 45°(typical)
Tilt	+20°, -5°	
Contrast Ratio	350 : 1 (typical)	
Brightness	200 cd /m2 (typical)	
Response Time	Tr=13 ms (typical)	
	Tr=27 ms (typical)	
Active Display Area	304.1mm x 228.1mm	
Temperature	Operating: 0°C ~ +40°C	
	Storage: -20°C ~ + 60°C	
Compliance	UL, TÜV/GS, CE, FCC-B, Energy Star.	
Power	Voltage 100-240 V	
	Consumption 30 Watts (max)	

Safety Precautions

This monitor is manufactured and tested on a ground principle that a user's safety comes first. However, improper use or installation may result danger to the monitor as well as to the user. Carefully go over the following WARNINGS before installation and keep this guide handy.

WARNINGS:

- ◆ This monitor should be operated only at the correct power sources indicated on the label on the rear end of the monitor. If you're unsure of the power supply in your residence, consult your local dealer or power company.
- ◆ Do not try to repair the monitor yourself as it contains no user-serviceable parts. The monitor should only be repaired by a qualified technician.
- ◆ Do not remove the monitor cabinet. There is high-voltage parts inside that may cause electric shock to human bodies, even when the power cord is disconnected .
- ◆ Stop using the monitor if the cabinet is damaged. Have it checked by a service technician.
- ◆ Put your monitor only in a clean, dry environment. Unplug the monitor immediately if gets wet and consult your service technician.
- ◆ Always unplug the monitor before cleaning it. Clean the cabinet with a clean, dry cloth. Apply non-ammonia based cleaner onto the cloth, not directly onto the glass screen.
- ◆ Keep the monitor away from magnetic objects, motors, TV sets, and transformer.
- ◆ Do not place heavy objects on the cable or power cord.
- ◆ For PLUGGABLE EQUIPMENT, the Socket-outlet shall be installed near the equipment and shall be easily accessible.

Care and Maintenance

Care

- Avoid exposing your monitor directly to sunlight or other heat source. Place your monitor away from the sun to reduce glare.
- Put your monitor in a well ventilated area. Do not place anything heavy on top of your monitor.
- Make certain your monitor is installed in a clean and moisture-free area.
- Keep your monitor away from magnets, motors, transformers, speakers, and TV sets.

Safety Tips:

- If smoke, abnormal noise or odor came out of your monitor, switch off the power immediately and call your service center.
- Never remove the rear cover of your monitor cabinet. The display unit inside contains high-voltage parts and may cause electric shock to human bodies.
- Never try to repair your monitor yourself. Always call your service center or a qualified technician to fix it.